

RK2

SYSTEMS

SAN DIEGO, CA

RK75PE-PF

PROTEIN FRACTIONATOR

Operations Manual

RK2 75 PE Protein Fractionator

- I. Introduction
 - II. Tools, parts and hardware
 - III. Unpacking procedures
 - IV. Assembly procedures
 - V. Appendix: Components
-

I. Introduction:

Congratulations on your purchase of the RK2 75 PE Protein Fractionator. This sophisticated filtration system is recommended for aquaria of up to 6300 gallons, and, when operated and maintained correctly, will provide many years of service, clean water, and health for aquatic life systems.



Should any technical issues arise during assembly or operation of this unit, please contact your RK2 Systems Distributor.

II. Tools, Parts and Hardware

The RK2 75 PE is simple to assemble, with only a few tools necessary and very few nuts, bolts and washers to keep track of.

Tools needed:

- Phillips screwdriver
- Flat head screwdriver
- 5/16 " open-end wrench
- 1/2" open-end wrench
- Teflon tape
- Box-cutter or similar blade
- One tube of Silicone Grease (recommended)



NOTE: Pipe wrenches are not recommended for assembly of the 75 PE and typically result in damage to the unit.)

Hardware included:

- (For top assembly)
- Twenty 5/16" x 2 1/4" bolts
- Twenty 5/16" finished hex nuts
- Twenty 5/16" x 3/4" standard flat washers
- Twenty 5/16" x 1 1/2" fender washers

- (For pump mount)
- Four 1/4" x 1" bolts
- Four 1/4" x 5/8" washers

III. Unpacking Procedures

1. Remove the staples at the top of the carton and remove the lid. (See Fig. A)



HELPFUL HINT: The lid makes a useful tray to keep all parts together for assembly.

2. Remove the staples that attach the cardboard exterior to the wooden pallet. (See Fig. A)

3. Slip the box cover off the top of the unit.

4. Cut and remove straps from boxes and pallet.

5. Remove the screws that secure the base of the 75 PE to the pallet. (See Fig. B)



HELPFUL HINT: A hand-truck is a great way to move the 75 PE around prior to final installation.

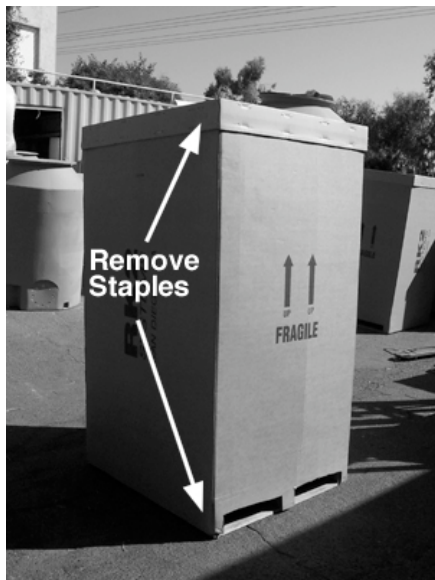

Fig. A

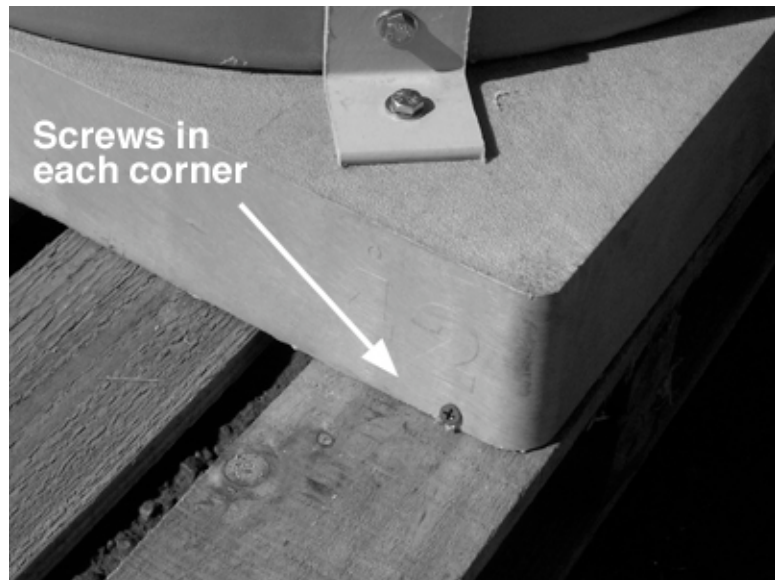

Fig. B

6. Remove pipes from inside the large grey Reaction Chamber. (See Fig. C)
7. Remove hanging tags from unit.
8. Look for masking tape that holds O-rings in place on the end of pipe fittings. **Remove any masking tape whenever you see it.** (See Fig. D)

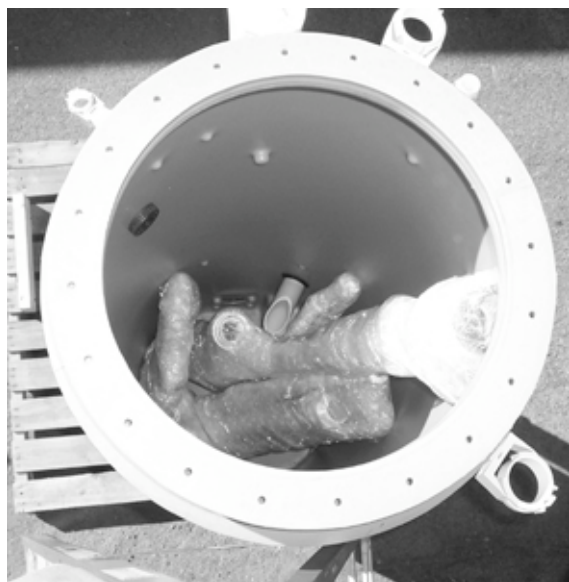

Fig. C



Fig. D

9. Unpack the Top & Cone Assembly from the larger box. (See Fig. E)
10. Set aside the Drop-Down Vent and Washer and Hardware Package. (See Fig. F1, F2)

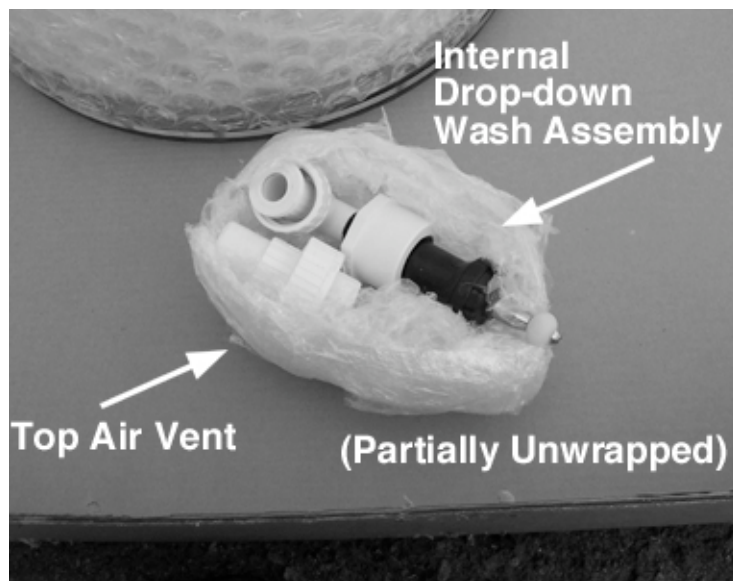

Fig. F1

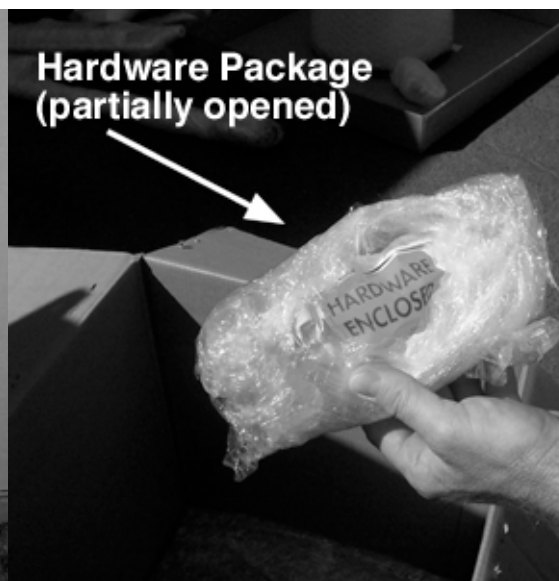





Fig. F2

11. Remove all bubble wrap from the Top & Cone Assembly. (See Fig. E)
12. Remove bolts and washers from bottom of Top & Cone Assembly, set aside.
13. Remove Pump and Base from smaller box.



Fig. E

IV. Assembly Procedures

Assembly should take you no more than a few hours. Follow the instructions below very carefully, taking special note of the Helpful Hints , Notes  and Warnings . This will help prevent breakage of any difficult-to-replace components. The Appendix, located at the end of this document, identifies the fixtures and assemblies you will be installing.



Again, should any technical issues arise during assembly or operation of this unit, please contact your RK2 Systems Distributor.

Mounting the Top/Cone Assembly

1. Separate the gaskets and parts as shown in Fig. 1.
2. Apply grease to seal in a complete circle inside of the circle of bolt holes as shown in Fig. 2.



HELPFUL HINTS: Do not get this grease on your clothes! It cannot dry, which is one of the reasons it's perfect for this job. As long as you've got the grease on your finger, you can also apply it to the rubber grommets as shown in Figs 9a and 9b, the Waste port in Fig. 10, and the intake port as shown in Fig. 24. However, if you do that you'll be skipping around so be sure to return back to Step 3, below, after you're finished greasing!



Fig. 1



Fig. 2

3. Place either of the two gaskets (both are identical) on top of the Reaction Chamber and align the holes as shown in Fig. 3.
4. Apply grease to the top of the gasket, as in Step 2, above. (See also Fig. 4)



Fig. 3



Fig. 4



HELPFUL HINT: Remembering to apply a ring of silicon grease (as shown above) inside the ring of bolt holes between all layers, you can continue to assemble the Gaskets, Cone and Top Assembly using the diagram shown below, and skip to Step 8. (Diagram not to scale)

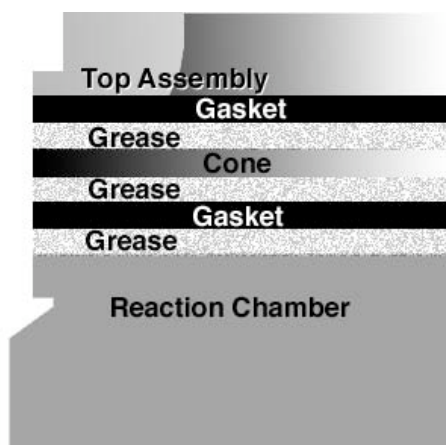

5. Place the cone on top of the gasket.
6. Apply grease along the top of the cone, as shown in Step 2, above. (See also Fig. 6)



Fig. 6

7. Apply the second gasket to the rim of the cone.
8. Apply grease to the top of the gasket, as in Step 2, above.
9. Apply grease to the rubber grommets on the Top (lid) of the unit, as shown in Figs. 9a and 9b.



Fig. 9a



Fig. 9b

10. Apply grease to the Waste Drain Port at the bottom of the Top (lid) assembly. (See Fig. 10 and never mind the “Lube Pipe with Soap” message on the grommet.)



Fig. 10

11. Insert the Air Vent into the hole at the top of the Top (lid), as shown in Fig. 11.
12. Insert the Drop-Down Washer, point it oriented toward the left of the center of the unit. (See Fig. 12)



Fig. 11

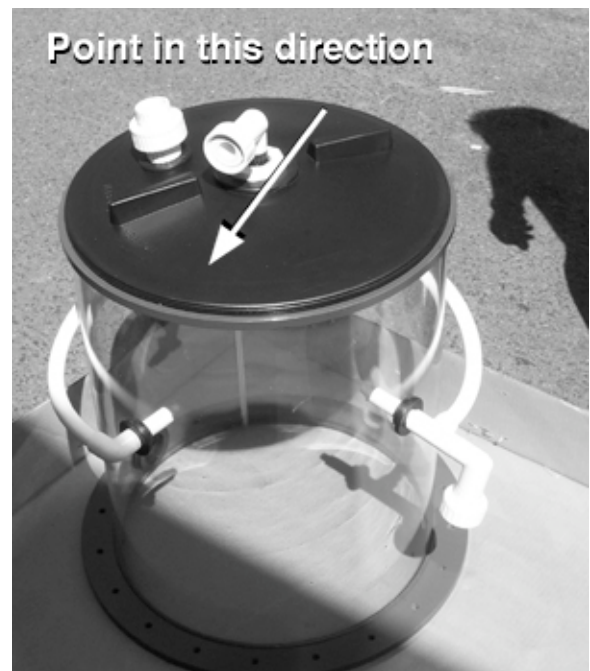

Fig. 12

- Place the Top (lid) on top of the gasket, and align the front of the Top Assembly to the RK2 insignia as shown in Fig. 13.
- Use a Phillips screwdriver to align the holes around the Top, through the gaskets, and cone to the Reaction Chamber.

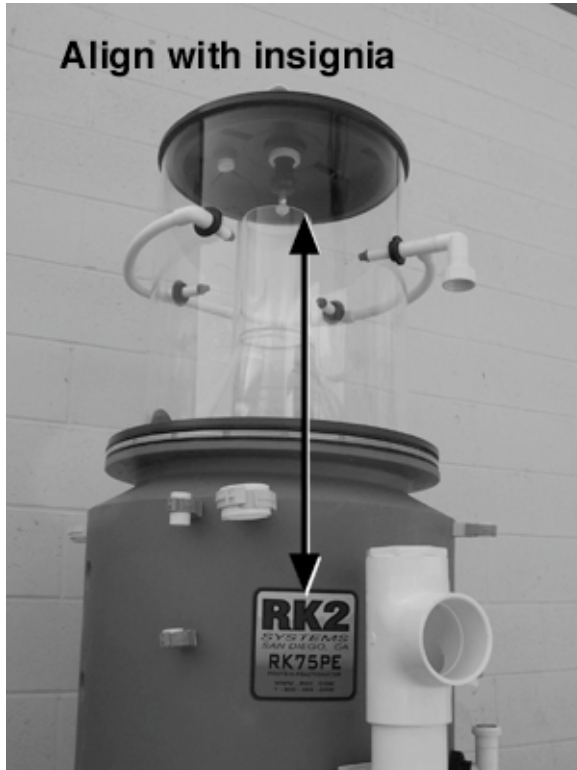

Fig. 13



Fig. 14

- Position the 5/16" x 3/4" standard flat washers and insert the 2 1/4" bolts into the 20 holes.



HELPFUL HINT: Initial bolt insertions may be more challenging than subsequent ones. It is preferable to thread all bolts through the holes rather than using a hammer or other implement to pound them through.



WARNING: At this point you may be tempted to apply the fender washers to the bottoms of the bolts and begin tightening them in a circular pattern around the top. **TRUST US:** If you do one side at a time, or go in a circular pattern, the result will be that one side rises too high, unequal pressure will result, and the acrylic material may fracture.

16. Once all the bolts are inserted, apply the fender washers and hand-tighten with the nuts. (See Fig. 17a) AGAIN, do not tighten in a circular pattern.
17. Tighten all 20 nuts and bolts in a criss-cross pattern to opposite corners, as per the Fig. 17a. Tighten until snug. (See Fig. 17b)

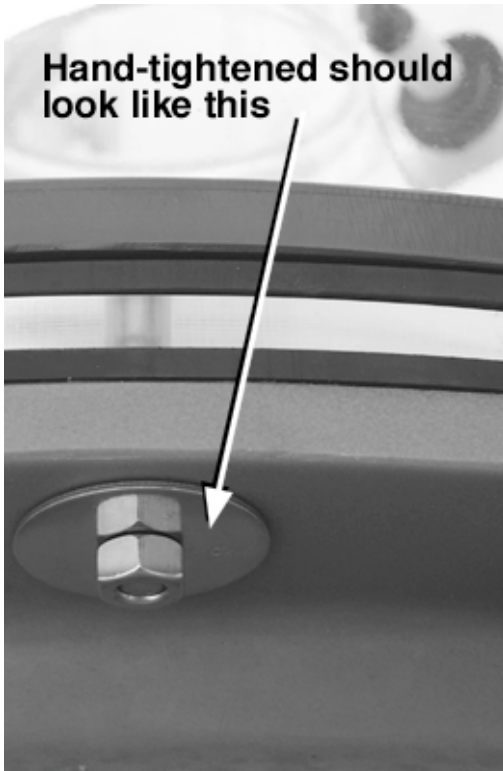

Fig. 17a

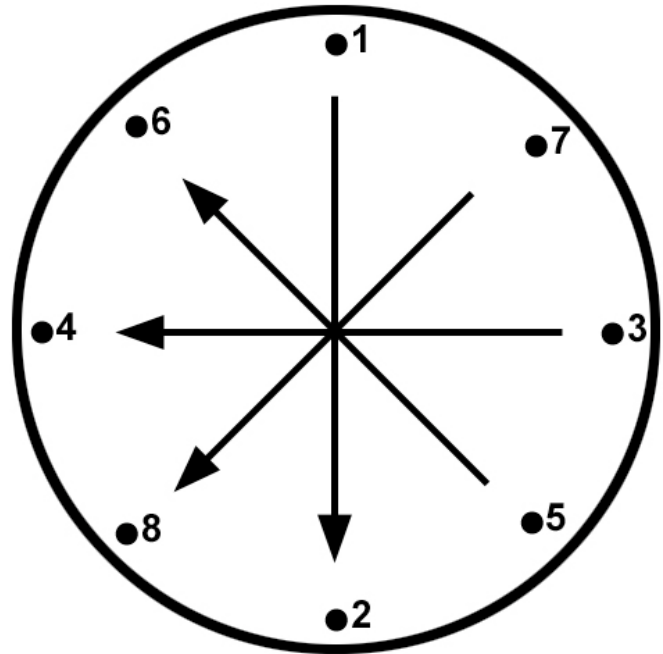

Fig. 17b



NOTE: The PSI of the water running through this part of the 75 PE is extremely LOW. Because of that, and because of all the grease you have applied, you do not need to tighten the bolts beyond what is snug. Leave no more than 1/8 of the thread of the bolt exposed, as shown in Fig. 17c.



Fig. 17c

Mounting the Pump

18. Position the Pump Base over the holes on the 75 PE Platform.
(See Fig. 18)
19. Place the Pump on top of the Pump Base. (See Fig. 19)



Fig. 18



Fig. 19

20. Using the 1/4" x 1" bolts and 1/4" x 5/8" washers provided, attach the Pump and Pump Base to the 75 PE Platform, as shown in Fig. 20.

21. Hand-tighten the unions as shown in Fig. 21a until surfaces are flush. See Fig. 21b to observe how the union looks when it is NOT flush.



WARNING: Do NOT USE A WRENCH to tighten this union, or a rupture will most likely result. Do not over-tighten this union!

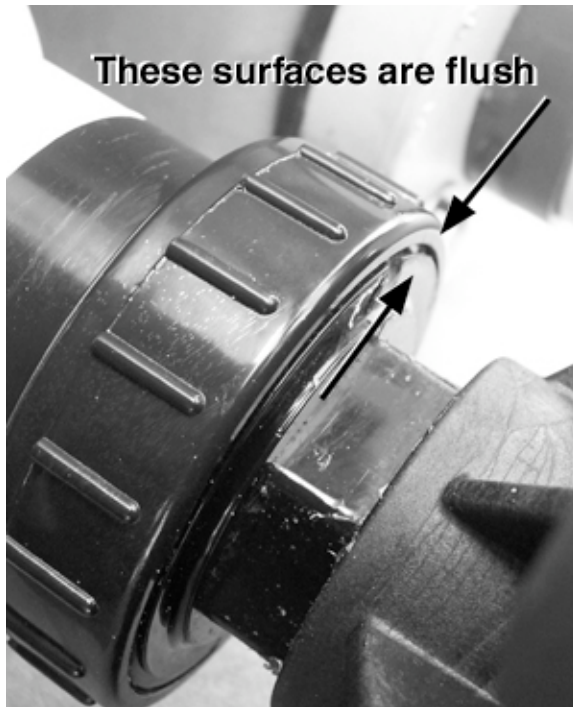

Fig. 21a

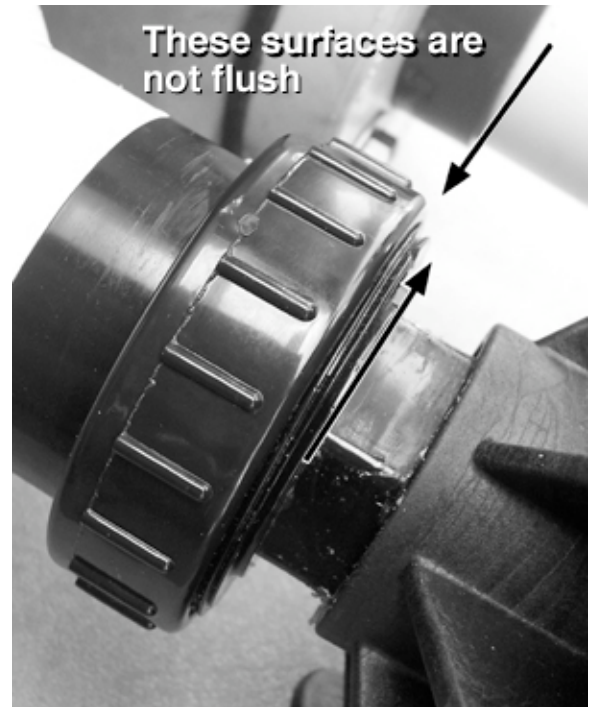

Fig. 21b

22. Remove bubble-wrap from all pipes.
23. Remove protective pipe inserts from clips.
24. Grease the Intake Port. (See Fig. 24)



Fig. 24

25. Attach the Venturi Intake Assembly by doing the following:

- A. Position the ball valve handle outward. (See Fig. 25a)
- B. Secure the pipe click located above the Venturi. (See Fig. 25a)
- C. Join the lower union of the Venturi Intake Assembly to the pump, as shown in Fig. 25b. Keep fairly loose.
- D. Join the upper union of the Venturi Intake Assembly to the Venturi. (See Fig. 25a)

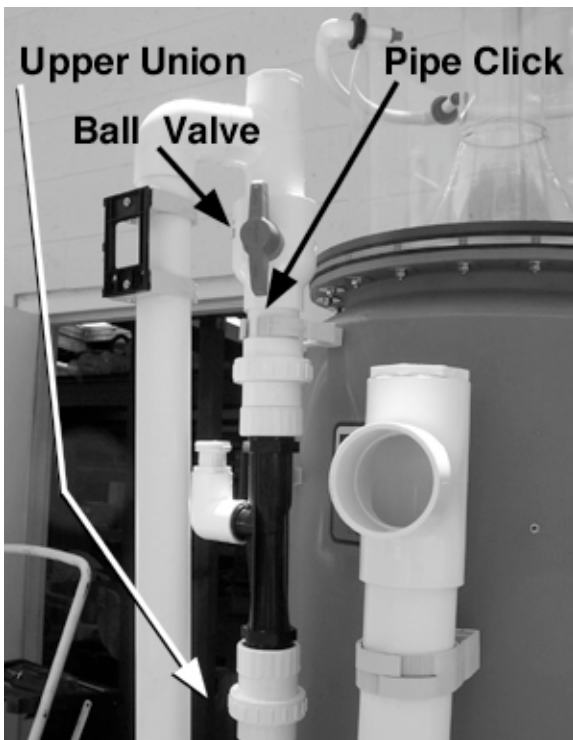

Fig. 25a



Fig. 25b

26. Attach the Air Intake Assembly. The non-threaded end attaches to the pipe click, and the 1" union attaches to the Venturi's Air Intake valve. Align straight, as shown in Fig. 26.
27. Hand-tighten the unions described in steps 25a and 25b, above.
28. Attach the Air Gauge by inserting over the end of the Air Intake Assembly and fasten it with the adjacent pipe click, as shown in Fig. 28.



WARNING: DO NOT GLUE the Air Gauge to the Air Intake Assembly. Maintenance requires that this component be removed and cleaned periodically.



Fig. 26

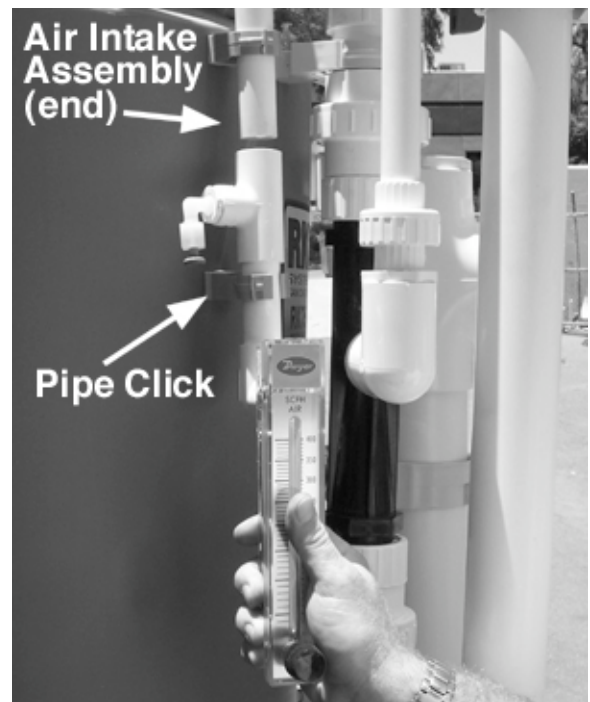

Fig. 28

29. Attach the Clear Sight Gauge to the pipe click and the 3/4" as shown in Fig. 29.

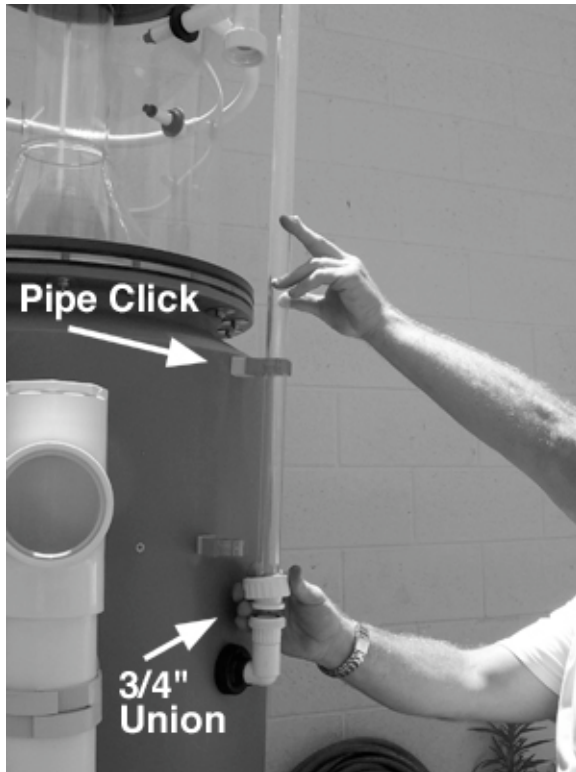

Fig. 29

30. Take the 2" Discharge Air Vent and cover the threading with Teflon tape, as shown in Fig. 30.



Fig. 30

31. Attach the 2" Air Vent by threading it into the 3" Discharge "T" Fitting, as shown in Fig. 31. Hand-tighten until snug.



Fig. 31

32. Install the External Wash Control Timer Assembly, which contains a Solenoid Valve and Timer Control.
- A. Place the External Washer Control by fitting it into the grooves on the black bracket. (See Fig. 32a)
 - B. Thread the long end of the External Wash Assembly (attached to the External Washer Control) to the 3/4" union on the Top (lid) assembly, and secure with pipe click in middle and _____ Valve on bottom. (See Fig. 32b) (pics don't show bottom valve attachment.)



Fig. 32a



Fig. 32b

33. Slide the Intake Valve Assembly into the rubber grommet on the side of the Reaction Chamber, as shown in Fig. 33.



Fig. 33

34. At the back of the unit, slide the Waste Drain into the 2" rubber grommet. Secure with the adjacent pipe click. (See Fig. 34)



Fig. 34

35. Install the Internal Wash Timer Assembly (which includes a Solenoid Valve and Timer Control).

- A. Attach Timer Control to the bracket located on the Venturi Intake Assembly, as shown in Fig. 35a.
- B. Temporarily remove the Ball Valve from the Solenoid Assembly.
- C. Thread the Ball Valve into the top of the Venturi Intake Assembly with the handle facing outward, as shown in Fig. 35b.
- D. Attach the Solenoid Assembly to the 2 3/4" union on the Internal Drop-Down Wash Assembly, as shown in Figs. 35c and 35d.



Fig. 35a



Fig. 35b



Fig. 35c

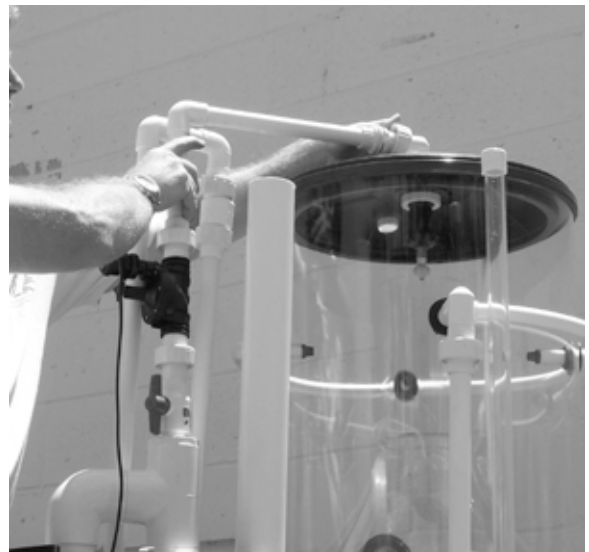

Fig. 35d

Congratulations! You have successfully assembled the RK 75 PE! Now it's time to plumb the RK 75 PE to the outside world.

36. Plumb the dirty water to the 2" Ball Valve Intake.
37. Plumb the Waste Drain to the sewage line.
38. Plum the 3" Discharge to reservoir.



WARNING: Immediately after the 3" Discharge, you must provide a minimum of 12" vertical drop. Do not install horizontal piping until you have provided 12" of vertical drop.

39. After you have completely connected the RK 75 PE, fire it up! Then inspect for any unions or nuts/bolts that leak, and hand tighten.

Appendix: Components

Included within the Reaction Chamber (main structural component of the RK 75 PE) and accompanying boxes there are some components wrapped in bubble-wrap that you will need to install. They are shown below for your reference:



Venturi Intake Assembly



Air Intake Assembly



Sight Gauge



External Wash Timer Assembly



Discharge Air Vent



Air Gauge

Appendix (continued)



Top Air Vent



Internal Drop-Down Wash Assembly



Intake Valve Assembly

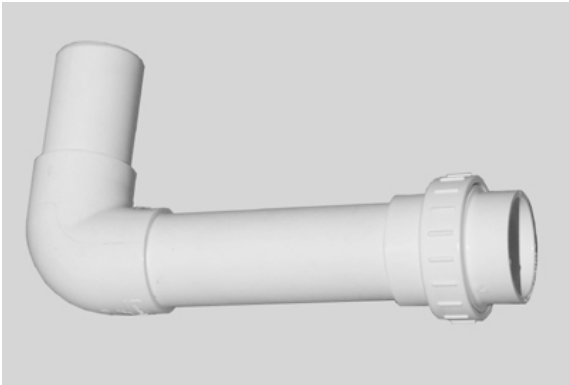

Waste Drain



Internal Wash Timer Assembly

RK75PE

PROTEIN FRACTIONATOR
HDPE Molded Tank

internal rinse system
seawater - 1 nozzle jet
retracting

riser configuration

external rinse system
high pressure - freshwater
4 nozzle jets.

L effluent drain union
back-side of
upper riser chamber
(not shown)

K electronic interval timer
3/4" fipt (rinse system) x2

H venturi anti-siphon
air/ozone intake

Kynar venturi
220 cfh gas injection
6230 clh. w/ ozone
& anti-syphon connx.

I filter discharge
return manifold

dedicated venturi pump
8.9/4.45 amp max.
@115/230v 50/60Hz 1ph.

O ozone vent union

upper riser chamber
clear acrylic

Clear Sight Gauge
(Tank level monitor)

2" vent - (discharge manifold)

M 2.0" intake (PVC Ball Valve Soc)
(standard location @ 170 °
optional 90 ° or 270 °)

reaction chamber
HDPE custom molded
24"dia. (46cm dia.)

N level control valve

HDPE base pad
24"x42"x3"

Floor

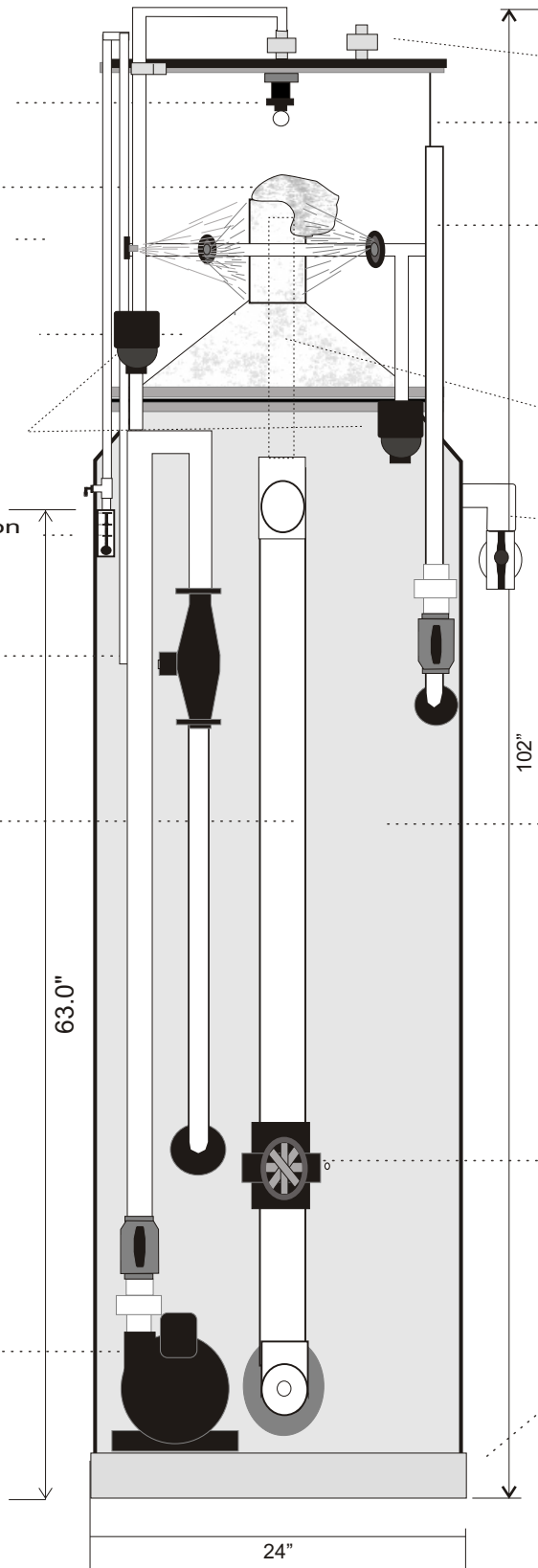

RK75PE PROTEIN FRACTIONATOR PORT CONNECTION CONFIGURATIONS

TOP VIEW:

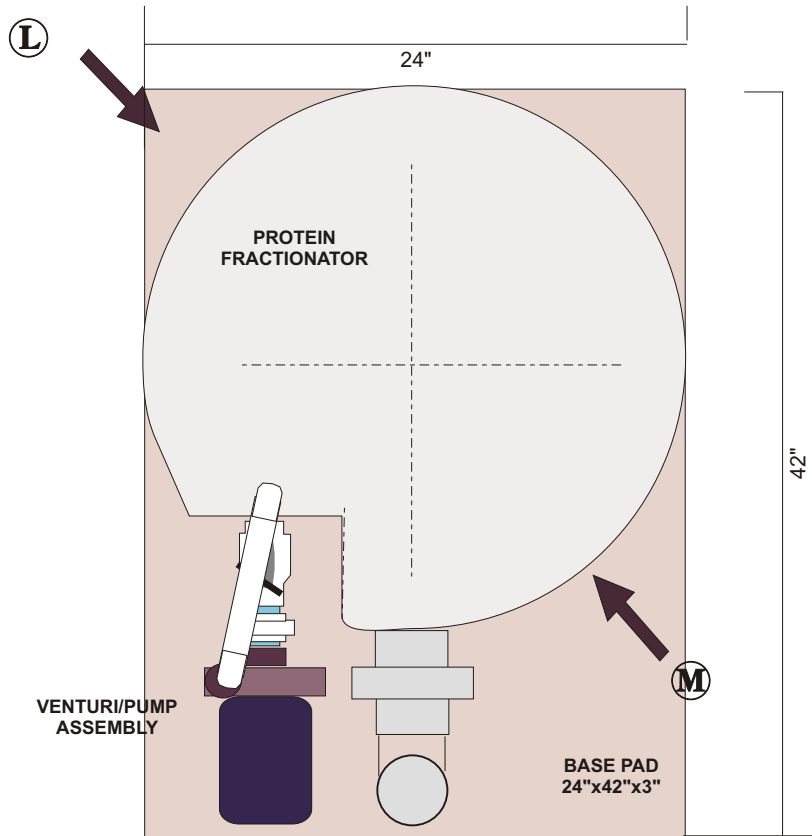

PORT ORIENTATION

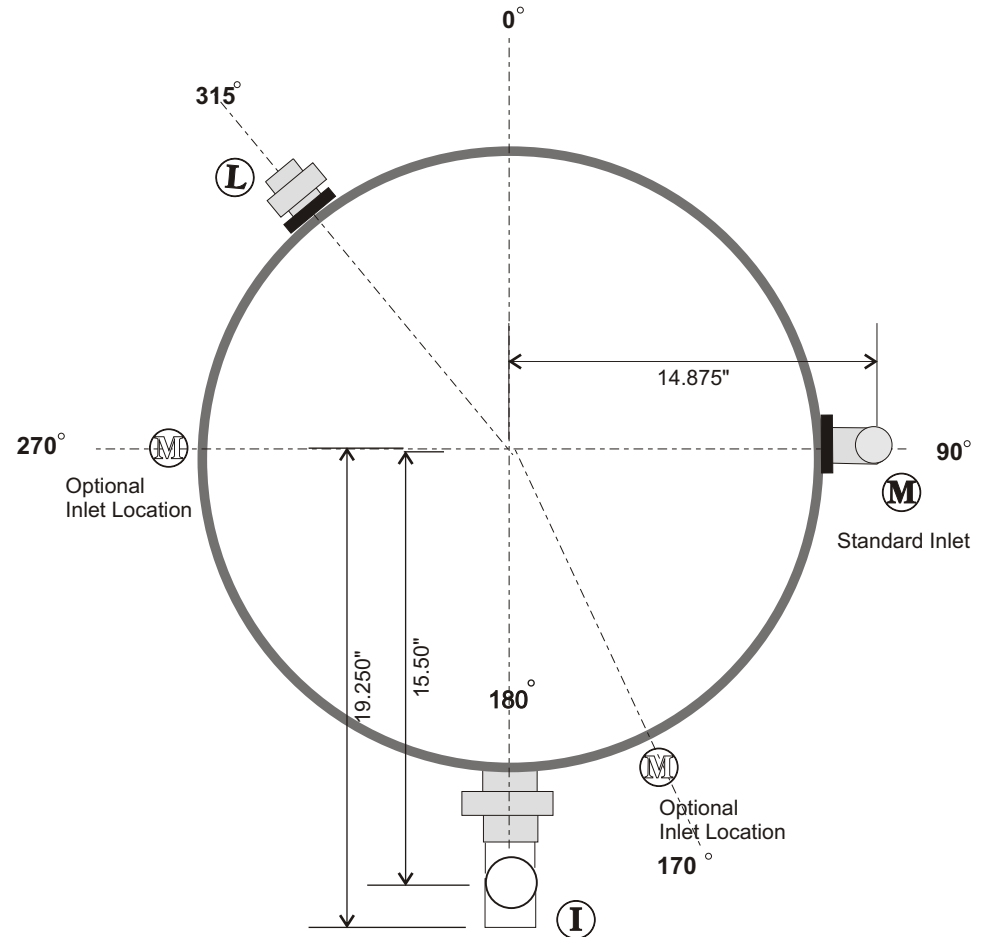

- (M)** = FILTER INLET. 1 PORT - 2" PVC SCH40 SLIP VALVE, VERTICAL POSITION. USER - OPTIONAL POSITIONS. HEIGHT = 62.75"
- (L)** = EFFLUENT DRAIN. 2" PVC SCH40 SLIP UNION, HORIZONTAL POSITION. HEIGHT = 76.0".
- (I)** = FILTER DISCHARGE. 3" PVC SCH40 SLIP TEE, HORIZONTAL POSITION. HEIGHT = 63.0" GRAVITY DRAIN, INITIAL 12" MUST DROP VERTICALLY, NO LATERAL PIPING.
- (O)** = OZONE VENT. 1" PVC SCH40 SLIP UNION. HEIGHT = 102.0"
- (K)** = RINSE SYSTEM. 3/4" PVC SCH80 SLIP UNION.

PROGRAMMING YOUR LCD WASHDOWN TIMER:

Follow Steps 8-14 to program you LCD Washdown timer for use with your RK2 Skimmer.

Under Step 12 – you will want to use the Cyclical Irrigation.

Step 13 – does not pertain to our use.

Following the shortened version of the manual with the pertinent information for use with your RK2 Skimmer is the full & complete manual for the LCD Washdown timer for your reference.

DIG controllers are programmed with the aid of four buttons:

- ⌚ Use to select the desired programming mode
- ⊖ Use to lower the value of the selected parameter (e.g. deducts an hour)
- ⊕ Use to raise the value of the selected parameter (e.g. adds an hour)
- ➡ Use to select the parameter to be changed (hour, minute, etc.). To implement the changes, the selected parameter must be flashing.

If no changes are implemented, the controller will always revert to the main screen.



8. PROGRAMMING

This section explains the programming features, use of buttons and the steps necessary to assign irrigation schedules. To program the controller use the left button to select the desired programming mode, the right button to make the entry flash and the plus minus buttons to change the value.

Note: Only a flashing character can be changed.

9. PROGRAMMING CURRENT TIME AND DAY OF THE WEEK

To enable the controller to operate properly, the current time and current day of the week must first be set. Steps below explain how to set the day and time.

Press the ⌚ hour digit will blink. Use the ⊕ or ⊖, to set the current hour (note: use of AM and PM designations). Press ➡ the minutes digit blink, set the current minute using ⊕ or ⊖. Press ➡ A blinking arrow will appear under "M" for "Monday". Use the ⊕ or ⊖ to move the arrow to current day. Press ⌚ to proceed to the next step.

Note: If the last data entered stops flashing, press the ⌚ again to resume programming.



10. TIME FORMAT (SWITCHING BETWEEN AM/PM AND 24 HOUR)

The default time format is AM/PM. There is also a 24 hour time format option that can be switched between the two formats.

Press ⌚ several times until ⌚ appears.

Press ⊕ hour digit will blink. Press the ⊕ or ⊖ simultaneously. The clock reading switches from AM/PM to a 24 hour time display or vice versa.

Note: You can switch the time display format at any step in this section of the programming process.

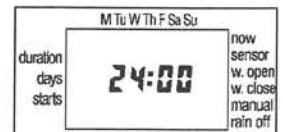

11. SETTING WATERING TIME (DURATION)

This setting determines the length of time that the valve will remain open.

Press until appears. Press , the hour/minute digits blink. Set the desired number of hours by pressing or . Press again, the minute digits blink. Set the desired number of minutes by pressing or . Repeat the same steps for seconds. Press to proceed to the next step.

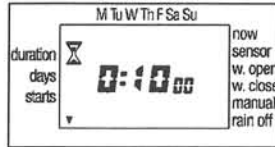

12. PROGRAMMING WATERING SCHEDULE

This setting determines which days the controller will operate. Choose either "A. Watering According to the Days of the Week" or "B. One-time Irrigation or Cyclical Irrigation".

Press until appears. Press . A blinking arrow appears at the top of the display, under Monday. At this stage you can set one of two options:

- Watering according to the days of the week,
- One time only watering, cyclical watering in minutes, hours or days.

CYCLICAL IRRIGATION

This option is used to program the controller to operate the system in a cyclical manner. Once every 1 minute up to 5 minutes, every 5 minutes up to 15 minutes, every 15 minutes up to 1 hour, every 1 hour up to 24 hours, and every day up to 30 days.

Press until appears. Press several times (to advance all the days of the week) until appears, and blinks on the display. With the display blinking, press or . The number of minutes, hours or days between watering cycles appears on the display. For

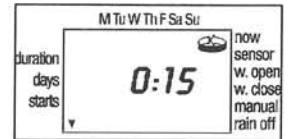

example if "every 15 minutes" is selected, your programmed watering duration will activate every 15 minutes during a 24-hour period. (see #19 for irrigation window). For example, if "every 30 days" appears, watering will take place once every thirty days, for the irrigation period as set in duration. To change the number of days press or . Press to proceed to the next step.

12

14. SETTING A CYCLICAL OR ONCE START TIME (WITH OPTION TO DELAY VALVE START TIME)

This program is used to pre-set the valve start time (only one start time available) and the number of days to delay the valve start time, the number of day(s) to delay option will appear on the display to the right of the irrigation start time above the word "days".

In this feature 0 days = program starts today; where 1 = program starts tomorrow, etc. (up to 30 days delay).

Press until START 1 appears or the last opening time entered appears on the display.

Press . The hours and the AM/PM digits



blink. Set the desired opening hour by pressing the or (note: AM and PM designations appear to the left of the hour digits). Press . The minute digits blink. Repeat the same step for setting the minutes and then the number of days to delay between watering cycles. Start time must be later than the current time in order for the cycle to start today (day = 0).

RK2

SYSTEMS

Owners Manual

Professional Quality
Corrosion Resistant
Energy-Efficient

Centrifugal Pumps



RK2 Pumps are end suction centrifugal units that are close coupled to 56J motors. They feature excellent corrosion resistance with molded Noryl pump housings, 316 ss hardware, pump seals of Monel ceramic and buna, and motors with PVC encapsulated stainless steel motor shafts. Numerous electrical motor configurations are available.

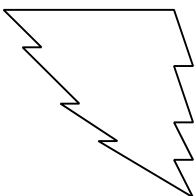

WARNING: PLEASE READ COMPLETELY BEFORE YOU INSTALL OR OPERATE YOUR NEW PUMP! NEVER RUN PUMP DRY! NEVER REVERSE ROTATION! NEVER EXCEED AN INTERNAL CASE PRESSURE OF: 100 PSI MAX NORYL

Thank you for choosing an RK2 System pump. It has been designed and built to provide you with years of dependable service. To insure maximum performance, we urge you to carefully follow the instructions in this manual. If you have any questions, call your nearest distributor or (760) 746-7400 for assistance.

Installation

Proper installation of your pump will help it to provide you with dependable, trouble free service. Please follow the general guidelines listed below to help insure maximum performance.

1. Position the pump as near the water intake source and as low as is practical. This will help avoid cavitation and maximize your pumps output.
 2. Protect the motor from excessive heat and moisture. It is best to provide shade from direct sun, and insure that it has proper ventilation. Excessive heat will shorten the motor life and void the warranty.
 3. Protect the motor against dirt, water and all foreign matter. If the motor has been flooded, shut off power and do not operate it until it has been checked by an authorized motor technician, and it has been certified safe to operate. If the motor is damaged by dirt or moisture it voids the warranty.
 4. Mount the motor where it cannot become submerged.
 5. The fittings used to connect to the housing should be plastic. All plumbing lines should be self supported and properly aligned. This will prevent undue stress to the housing.
 6. The intake to the pump should never be restricted. Keep your suction lines as free of elbows, fittings and valves as possible. **The use of large diameter pipe will help provide adequate flow**, as it reduces friction loss.
 7. This is a non self priming pump and is best suited with a flooded suction. The pump housing, and the entire suction line must be filled with fluid for it to operate properly. **Do not run dry!**
-

Electrical

1. Make sure the power is disconnected at the breaker before wiring the motor.
2. Make sure that the motor is wired so that it matches the supply voltage (115, 208, 230 or 460 volt). If they do not match it will damage your motor and void the warranty.
3. **Use a wire of adequate gauge** and length to prevent electrical line losses. The use of heavier gauge wire will allow the motor to run cooler and more efficiently.
4. Make sure all connections are clean and tight. Properly ground the motor. (There is normally a green ground terminal located on the inside of the motor connection box.) Make sure the ground wire is properly connected to an electrical service ground. Connect the pump permanently to an adequately sized circuit. It is best to have a dedicated circuit that won't suffer voltage drop from other loads.

THREE PHASE MOTORS: 1 1 1

5. Insure proper motor *rotation*. When viewed from the shaft end, the motor must rotate counterclockwise. Incorrect rotation will destroy the pump and motor.
Note: The motor leads must be energized in the correct order. If you are not sure of the sequence of your incoming supply line, **remove the volute from the pump**, connect the power and check rotation. When the rotation is correct, reinstall the volute. Do not test with volute in place! **Never test rotation by bumping a switch!!! This will destroy the pump and void the warranty!!!!** If it is incorrect, exchange any two of the connected leads and retest.

Disassembly

1. Shut off the power to the motor before disconnecting any electrical wiring from the back of the motor.
2. Disassemble the volute from the bracket motor assembly by removing the seven $\frac{1}{4}$ 20 x 2 $\frac{3}{4}$ cap screws. (The volute may be left in-line if you wish.)
3. Remove the cap covering the back end of the motor shaft and with a large screwdriver or wrench, prevent shaft rotation while unscrewing the impeller counterclockwise.
4. Remove the ceramic piece from the impeller hub.
5. Detach the bracket from the motor by removing the four $\frac{3}{8}$ " cap screws, and slide it forward, away from the motor.
6. Remove the carbon-graphite seal from the bracket by pressing it out from the back. Do not dig it out from the front!

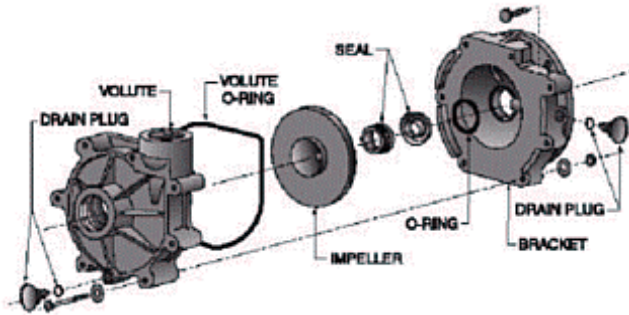

Pump End Assembly

1. Check all pump parts and clean as needed.
2. If the motor shaft has corrosion build up, use emery cloth to clean it.
3. Install the O-ring into the O-ring gland in the bracket bore.
4. Press the carbon seal head into the bracket bore. **CAUTION! Press only on the stainless steel or polypropylene shell, NOT ON THE DELICATE CARBON FACE! DO NOT TOUCH THE CARBON SEAL FACE!**
5. Note: It is not recommended to use a slinger in conjunction with a PVC shaft sleeve.
6. Mount the bracket onto the motor C-face using four $\frac{3}{8}$ " cap screws and tighten them snugly.
7. Press the ceramic into the impeller hub. It helps to moisten the rubber boot with water first. The ceramic **MUST SIT FLAT**. If one side is higher than the other, the seal will leak! The smooth face must be up and exposed.
8. Screw the impeller clockwise onto the motor shaft and tighten. You can hold the shaft stationary at the opposite end of the motor with a large screwdriver or wrench..
9. Place the large O-ring in the groove in the volute. Note: It is easiest to lay the volute, suction side down, place the O-ring in the groove, and lower the bracket/motor assembly down onto the volute. (So the O-ring doesn't pop out.)
10. Install the seven $\frac{1}{4}$ " x 2 $\frac{3}{4}$ " socket cap screws with washers and tighten in a cross pattern until they are reasonably snug. (No need to overtighten).
11. Place the small O-rings onto both drain plugs, and screw them into the $\frac{1}{4}$ " holes in the volute and bracket.

Trouble Shooting Aid

Motor Will Not Start

1. Check for voltage present at connection box.
2. Check that the supply voltage matches the motor voltage connections.
3. Check that you have proper line voltage.
4. Check that all connections are sound.
5. Check that the motor shaft rotates easily by hand. (This can be checked at the rear of motor by turning with screwdriver or wrench.)

Motor Won't Start, But It Hums.

1. Check items 2-5 above.
2. Check that there is no foreign matter lodged between the contacts on the start switch.
3. Check to insure the capacitor is functioning properly.

Motor Gets Hot And Shuts Down.

1. Check for proper wiring in the motor box. The supply voltage must match the motor voltage connections.
2. Check the voltage at the motor box, with the motor and all other loads normally on the circuit running. It must not be significantly below the nominal voltage.
3. Check to see if the motor shaft turns without excessive resistance. Bad bearings, or a clogged impeller can cause excessive resistance.
4. Make sure any check valves are installed in the correct direction.
5. Check that the pump impeller and the housing are not clogged or blocked.

Pump Will Not Hold A Prime.

1. Check for defective joints at all pipe fittings. They must be air tight.
2. Check for a defective check valve or foot valve.
3. Check for a leaking seal.

RK2 PROTEIN FRACTIONATOR FLOW CONTROL SETTINGS

INITIAL START-UP

1.) WITH THE VENTURI PUMP(S) OFF, OPEN ALL WATER VALVES FULLY EXCLUDING INLET SUPPLY. OPEN THE FRACTIONATOR INLET VALVES, THE VALVES SHOULD BE ADJUSTED TO ALLOW A MAXIMUM FLOW RATE AT WHICH THE FILTER IS RATED.

CHECK FOR LEAKS. IF ANY UNIONS HAVE LEAKS HAND -TIGHTEN ONLY. IF THE UNION CONTINUES TO LEAK THE FITTING NEEDS TO EXAMINED FOR CRACKS AND CORRECT "O" RING SEATING.

LEAKS AT THE FLANGE AREA SHOULD BE ADDRESSED BY TIGHTENING THE FLANGE BOLTS IN A CRISS-CROSS PATTERN. THE SCH80 FLANGES WITH INSERTS IN THE TANK WALL SHOULD TORQUED TO A MAXIMUM OF 25LBS. THE FLANGE CONNECTING THE CLEAR CHAMBER TO THE TANK SHOULD TIGHTENED IN A CRISS-CROSS PATTERN ½ TURN PAST HAND TIGHT. INCORRECT TIGHTENING OF THIS FLANGE WILL FRACTURE THE UPPER CHAMBER.

2.) TURN ON THE VENTURI PUMP(S). ADJUST THE AIR/OZONE FLOW INTO THE FRACTIONATOR WITH THE NEEDLE CONTROL VALVE . DIFFERENT MODEL VENTURIS HAVE DIFFERENT FLOW RATES. CHECK THE GAUGE WITH THE NEEDLE VALVE SET TO FULL FLOW. THE TOTAL FLOW SHOULD THEN BE REDUCED BY 20%. THIS FLOW REDUCTION WILL CREATE A VACUUM OF 1" TO 2" IN THE VENTURI GAS INTAKE LINE. THIS IS THE CORRECT SETTING. IF OZONE IS APPLIED, THE AIR FLOW SHOULD BE REDUCED BY THE AMOUNT OF OZONE BEING INTRODUCED SO THAT THE TOTAL COMBINED FLOW REMAINS THE SAME.

EXPLODED VIEW

AIR - OZONE INTAKE
AIR FLOW ROTAMETER
AND FLOW CONTROL VALVE

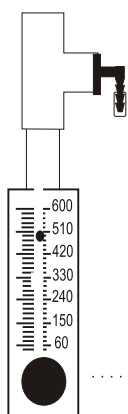

OZONE CONNECTION
(THIS INLET MUST BE
SEALED IF NO OZONE
IS CONNECTED.)

AIR FLOW
NEEDLE VALVE CONTROL

3.) FINAL FOAM LEVEL ADJUSTMENT IS CONTROLLED WITH THE FILTER DISCHARGE VALVE. ALL OTHER VALVES SHOULD REMAIN IN THERE SET POSITIONS AND THE DISCHARGE VALVE ADJUSTED AS NECESSARY FOR CHANGING CONDITIONS AND TO ACHIEVE THE CORRECT FOAM CONSISTENCY.
(SEE "PROPER PROTEIN ADJUSTMENT")



Series RM Rate-Master® Flowmeters

Specifications - Installation and Operating Instructions



Fig. 1

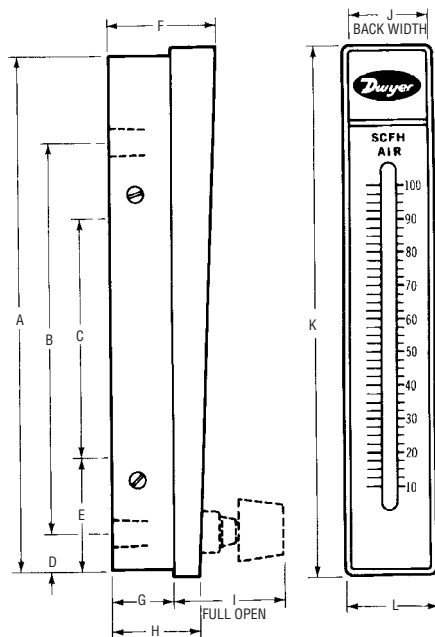

Fig. 2

Dwyer Series RM Rate-Master® Flowmeters are furnished in three models (see Fig. 2), each available in a broad array of flow ranges with direct reading scales for air, gas or water. Installation, operation and maintenance are very simple. Only a few common-sense precautions must be observed to assure long, trouble-free service.

CAUTION: Dwyer Rate-Master® Flowmeters are designed to provide satisfactory long-term service when used with air, water or other compatible media. Refer to factory for information on questionable gases or liquids. Avoid solutions of acids, bases or salts having a pH below 5.0 or above 8.5. Caustic solutions, antifreeze (ethylene glycol) and aromatic solvents should definitely not be used.

Calibration

Each Rate-Master® Flowmeter is calibrated at the factory. If at any time during the meter's life, you wish to re-check its calibration, do so only with devices of certified accuracy. DO NOT attempt to check a Rate-Master® Flowmeter with a similar flowmeter, as seemingly unimportant variations in piping and back pressure may cause noticeable differences in the indicated reading. If in doubt, return your Dwyer Rate-Master® Flowmeter to the factory. Its calibration will be checked for you at no charge. Before proceeding with installation, check to be sure you have the Rate-Master model and flow range you require.

LOCATION: Temperature, Pressure, Atmosphere and Vibration:

Dwyer Rate-Master® Flowmeters are exceptionally tough and strong. They are designed for use at pressures up to 100 psi (6.89 bar) and temperatures up to 130°F (54°C).

DO NOT EXCEED THESE LIMITS! The installation should not be exposed to strong chlorine atmospheres or solvents such as benzene, acetone, carbon tetrachloride, etc. The mounting panel should be free of excessive vibration, as it may prevent the unit from operating properly.

Dimensions in Inches (Centimeters)			
	Model RMA	Model RMB	Model RMC
A	4 -9/16 (11.59)	8-1/2 (21.59)	15 -1/8 (38.42)
B	3 (7.62) 1/8 NPT CONN.	6-7/16 (16.35) 1/4 NPT CONN.	12 -1/4 (31.12) 1/2 NPT CONN.
C	1-5/8 (3.17) 10 - 32 Thds.	3-15/16 (8.56) 1/4 - 20 Thds.	8-3/4 (10.72) 10 - 32 Thds.
D	3/8 (.95)	5/8 (1.59)	1 (2.54)
E	1-1/16 (2.60)	1-7/8 (3.42)	2-3/4 (5.83)
F	1-3/16 (2.73)	1-3/4 (3.29)	2-1/4 (5.33)
G	3/4 (1.91)	1 (2.54)	1-7/16 (2.98)
H	1 (2.54)	1-7/16 (2.98)	1-31/32 (3.51)
I (OPEN)	1-3/8 (3.49)	1-13/16 (4.60)	2-1/2 (6.35)
J	3/4 (1.91)	1-1/4 (3.18)	2 (5.08)
K	4-13/16 (12.22)	8-3/4 (22.23)	15-3/8 (39.05)
L	1 (2.54)	1-1/2 (3.81)	2-1/4 (5.72)

PANEL CUTOUT FOR FLUSH MOUNTING			
HIGH WIDE	4-5/8 (11.75)	8-9/16 (21.75)	15 -3/16 (38.58)
	7/8 (2.22)	1-5/16 (3.33)	2-1/16 (5.24)
PANEL HOLE SIZES FOR SURFACE MOUNTING			
PIPE BOLT	7/16 (1.11)	5/8 (1.59)	15/16 (2.38)
	1/4 (0.64)	9/32 (0.71)	13/32 (1.03)

Inlet Piping Run: It is good practice to approach the flowmeter inlet with as few elbows and restrictions as possible. In every case, the inlet piping should be at least as large as the connection to the flowmeter; i.e., 1/8" Iron Pipe Size for RMA models 1/4" IPS for RMB models, 1/2" IPS for RMC models. Length of inlet piping makes little difference for normal pressure-fed flowmeters.

For flowmeters on vacuum air service, the inlet piping should be as short and open as possible. This will allow operation near atmospheric pressure and thereby insure the accuracy of the device. (**Note:** for vacuum air service, the flow control valve, if any, should be on the discharge side of the flowmeter. Either the TMV unit or a separate in-line valve may be applied.)

Discharge Piping: As on the inlet, discharge piping should be at least as large as the flowmeter connection. Also, for pressure-fed flowmeters on air or gas service, the discharge piping should be as short and open as possible. This will allow operation of the flow tube at near atmospheric pressure and insure the accuracy of the device. This is of less importance on water or liquid flowmeters, as the flowing medium is generally incompressible and moderate back pressure will not affect the accuracy of the instrument as calibrated.

POSITIONING AND MOUNTING

All Rate-Master® Flowmeters must be mounted in a vertical position with inlet connection at the bottom rear and outlet at the top rear.

Bezel or Through-Panel Mounting: Make panel cutout using appropriate dimensions from Fig. 2. Flowmeter must fit into panel freely without forcing or squeezing. Insert the flowmeter from the front of the panel and install the mounting clamps from the rear. Insert and tighten the clamp bolts in the locations shown in Fig. 3. Do not exceed 5 in./lbs. Make connections to inlet and outlet ports using small amount of RTV sealant or Teflon® thread tape to avoid leakage. Avoid excess torque, which may damage the flowmeter body.

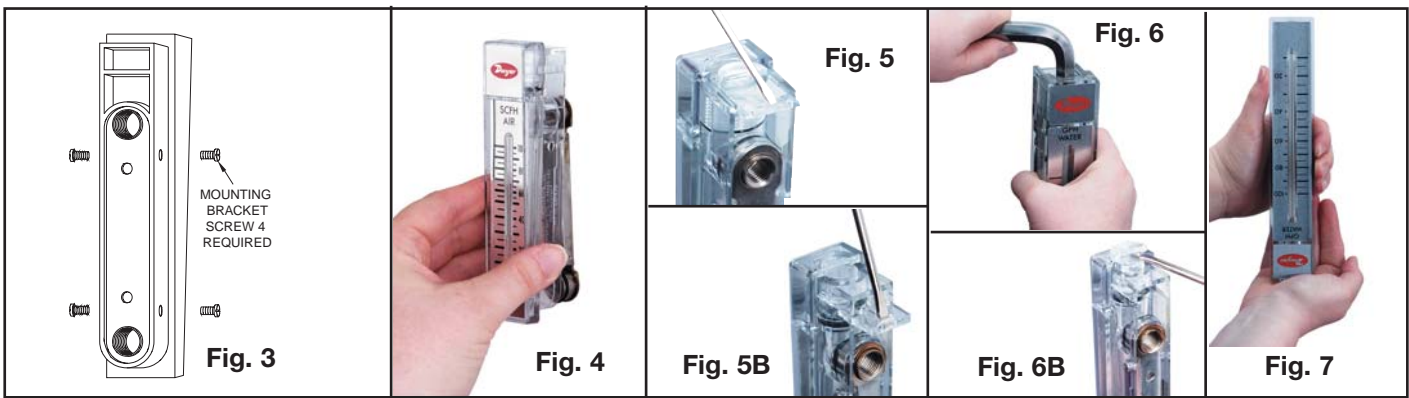

Surface Mounting: Drill appropriate holes in panel, using the dimensions shown in Fig. 2. Hold the flowmeter in position in front of the panel and install the clamp bolts from the rear. (The mounting clamps may be used as washers, if desired, by installing them backwards or straightening them out.) Pipe up inlet and discharge following the directions in the previous sections.

Surface Mounting on Piping Only: An alternate method of surface mounting, omitting the clamp bolts and supporting the flowmeter solely on the connecting piping, is possible. For this method, extra-long or straight pipe threads should be used so that nuts may be run onto the pipe and later tightened against the back of the panel to retain the unit in proper position. Use appropriate hole layout in formation from Fig. 2, but omit the small holes.

Surface Mounting on Piping Only Without Panel: For a temporary or laboratory type installation, the panel may be omitted altogether and the flowmeter installed directly in rigid piping. Its light weight permits this without difficulty.

OPERATION

To start system, open valve slowly to avoid possible damage. Control valves on BV and SSV models are turned clockwise to reduce flow, counter-clockwise to increase flow. A nylon insert is provided in the threaded section of the valve stem to give a firm touch to valve and to prevent change of setting due to vibration.

The performance of low range units used in air or gas applications may be affected by static electricity. Excessive static charge may cause the ball float to behave erratically or provide a false reading. To ensure the proper function of the unit, the application should be designed to minimize or dispel static electricity.

The standard technique for reading a Variable Area Flowmeter is to locate the highest point of greatest diameter on the float, and then align that with the theoretical center of the scale graduation. In the event that the float is not aligned with a grad, an extrapolation of the float location must be made by the operator as to its location between the two closest grads. The following are some sample floats shown with reference to the proper location to read the float.

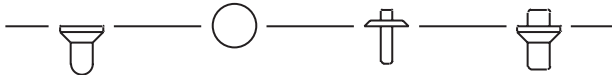

Variable Area Flowmeters used for gases are typically labeled with the prefix "S" or "N", which represents "Standard" for English units or "Normal" for metric units. Use of this prefix designates that the flowmeter is calibrated to operate at a specific set of conditions, and deviation from those standard conditions will require correction for the calibration to be valid. In practice, the reading taken from the flowmeter scale must be corrected back to standard conditions to be used with the scale units. The correct location to measure the actual pressure and temperature is at the exit of the flowmeter, except when using the Top Mounted Valve under vacuum applications, where they should be measured at the flowmeter inlet. The equation to correct for nonstandard operating conditions is as follows:

$$Q_2 = Q_1 \times \sqrt{\frac{P_1 \times T_2}{P_2 \times T_1}}$$

Where: Q_1 = Actual or Observed Flowmeter Reading
 Q_2 = Standard Flow Corrected for Pressure and Temperature

P_1 = Actual Pressure (14.7 psia + Gage Pressure)
 P_2 = Standard Pressure (14.7 psia, which is 0 psig)
 T_1 = Actual Temperature (460 R + Temp °F)
 T_2 = Standard Temperature (530 R, which is 70°F)

Example: A flowmeter with a scale of 10-100 SCFH Air. The float is sitting at the 60 grad on the flowmeter scale. Actual Pressure is measured at the exit of the meter as 5 psig. Actual Temperature is measured at the exit of the meter as 85°F.

$$Q_2 = 60.0 \times \sqrt{\frac{(14.7 + 5) \times 530}{14.7 \times (460 + 85)}}$$

$Q_2 = 68.5$ SCFH Air

CAUTION: Do not completely unscrew valve stem unless the flowmeter is unpressurized and drained of any liquid. Removal while in service will allow gas or liquid to flow out the front of the valve body and could result in serious personal injury. For applications involving high pressure and/or toxic gases or fluids, special non-removable valves are available on special order. Please contact factory for details.

MAINTENANCE

The only maintenance normally required is occasional cleaning to assure reliable operation and good float visibility.

Disassembly: The flowmeter can be disassembled for cleaning simply as follows:

1. Remove valve knob from RMB or RMC -BV or -SSV units by pulling the knob forward. It is retained by spring pressure on the stem half-shaft so that a gentle pull will remove it. On RMA-BV or -SSV models, turn the valve knob counter-clockwise until the threads are disengaged. Then withdraw the stem from the valve by gently pulling on the knob.
2. Remove the four mounting bracket screws located in the sides of the flowmeter. See Fig. 3. Pull the flowmeter body gently forward away from the back plate to avoid undue strain on the body. Leave the piping connections intact. There is no need to disturb them. See Fig. 4.
3. Threaded body style flowmeters - Remove the slip cap with a push on a screwdriver as shown in Fig. 5. Remove the plug ball stop as shown in Fig. 6 using allen wrench sizes as follows: Model RMA - 1/4", Model RMB - 1/2" and Model RMC - 3/4" Threadless body style flowmeters - Release the plastic retaining clip with a screw driver (Figure 5B), it will unclip from the valve body (TMV Option) or the plug ball stop, slide the clip back until the valve body or ball stop can be removed. The clip will remain in the body for convenience. Using a screwdriver gently lift up on the plug in the groove as shown in Figure 6B until the o-ring seal is released and remove the plug. For the TMV option gently pull up on the valve knob to release the valve body seals and remove the valve.
4. Take out the ball or float by inverting the body and allowing the float to fall into your hand, as shown in Fig. 7. (Note: It is best to cover the discharge port to avoid losing the float through that opening.)

Cleaning: The flow tube and flowmeter body can best be cleaned with a little pure soap and water. Use of a bottle brush or other soft brush will aid the cleaning. Avoid benzene, acetone, carbon tetrachloride, alkaline detergents, caustic soda, liquid soaps (which may contain chlorinated solvents), etc. Also, avoid prolonged immersion, which may harm or loosen the scale.

Reassembly: Simply reverse steps 1 through 4 and place the flowmeter back in service. A little stopcock grease or petroleum jelly on the "O" rings will help maintain a good seal as well as facilitate assembly. No other special care is required.

Teflon® is a registered Trademark of E.I. DuPont Company

©Copyright 2005 Dwyer Instruments, Inc.

Printed in U.S.A. 9/05

FR# 56-440197-00 Rev. 16

Proper Protein Fractionator Adjustment

A protein skimmer (actually a protein fractionator) is not a 'plug and play' piece of equipment. It requires close attention to achieve proper adjustment. This proper adjustment is critical to achieving the maximum performance from the unit.

The fractionator is adjusted by creating back pressure at the discharge by throttling the discharge valve. The gas intake and water inlet need to be set to their recommended flow rates. Throttling back the discharge valve increases the back pressure and raises the foam level in the upper chamber. This is basically a hydraulic balancing procedure. (Do not throttle water or air flow to and from the venturis to control foam height. Venturi water valves should run in the open position. Venturi air intakes should be adjusted to a 1" to 2" vacuum.)

The fractionator needs to be adjusted to a level that consistently produces an effluent the color of weak tea or ginger ale. Lowering the foam level to the point where it only produces dry foam and a dark effluent inhibits the removal of waste products. A new installation that has not had any fractionation for more than a few days will require 2 to 7 days for the system to achieve a level of stable organic removal.

Protein fractionators remove compounds from the water by injecting fine bubbles into the water. Organic compounds 'stick' to the surface tension of the water which includes the surface of the bubbles. As the organic laden foam rises into the upper chamber it overflows into the collection area.

The discharge valve adjustment combined with the Bio-load (and certain additives) will affect the foam level. If the foam level is set too low the protein fractionator will only remove a small amount of waste even from very dirty water. Waste levels which are below this threshold remain in the water since the protein fractionator is not adjusted to remove them. The result of this level of adjustment is a very dark, concentrated waste extract from the protein fractionator. When this is occurring the aquarist has no way of determining how efficient the protein fractionator is working other than by observing the color of the water in the aquarium.

Adjusting the level too high creates a situation where the fractionator is removing a large amount of water that has very little dissolved organics.

To properly adjust a protein fractionator takes at least several days of observation and adjustments. You should allow a minimum of a half an hour between adjustments to allow the hydraulics to settle into balance. There are a couple things to remember to achieve proper adjustment. The first is the protein fractionator only removes waste to the threshold you have set. As it approaches this threshold it removes less and less resulting in a concentrated extract. The other is that the extract should be roughly the color of ginger ale or weak tea. If it is darker, the threshold is set too low.

To adjust the fractionator properly the following must be done:

1. Make sure the venturi and inlet flows are set to the recommended rates.
2. Adjust the protein fractionator by throttling the discharge valve so that the extract is about the color of ginger ale or weak tea. Ideally you will produce a sudsy foam that is between the consistency of water and shaving cream.
3. Let it run, even though it may run wet for a while. As it approaches the new threshold level for waste extraction it will begin to slow down and the extract will become darker and more concentrated. When this happens repeat step 1 and step 2.
3. When the point is reached that the protein fractionator does not slow down after a few days then it can be assumed that the protein skimmer is properly adjusted. In the case of very dirty water this process may take quite a number of adjustments and may take longer to slow down the first time. Keep the protein fractionator adjusted so that the extract does not become dark.

Adding feed, organic matter or animals to the water will cause the foam level to rise, sometimes substantially. Certain oils and other compounds will inhibit foam production. If the skimmer level “bounces” or changes radically over a short period, there may be hydraulic issues with the way the filter is plumbed and/or vented.

NEVER BLOCK THE DISCHARGE VENT UNION AT THE TOP OF THE FRACTIONATOR. This will pressurize the unit, and void all warranties. If you connect any filters or ozone destruct equipment to the top vent, the vent must remain free-flowing or at a slightly negative pressure.

To maintain an efficient fractionator the upper chamber must remain clean and the rinse system in the upper chamber needs to be working properly. The chamber should be accessed through the top cover and cleaned manually every 90 days or if the rinse system has been out of operation for more than 3 hours. With a properly adjusted protein fractionator the water will be noticeably cleaner. Ideally aquarium water should be clear and colorless. The closer to this goal the better.

RK2

SYSTEMS

421A SOUTH ANDREASEN DRIVE • ESCONDIDO, CA 92029 • 760-746-7400 • FAX 760-746-7460

PRODUCT WARRANTY TERMS

RK2 Systems, Inc. (The Seller) warrants to the original purchaser, that products of its own manufacture will be free from defects in materials or workmanship, under normal use and service, for a period of one year from the date of purchase (with the exception of a vessel, which is warranted for three years). The Seller's obligations under this Warranty are limited to replacing or repairing or giving credit for, at its option, any of its said products which shall, within one year after purchase, be returned to the Seller's place of origin, transportation charges prepaid, and which are, after products examined, disclosed to the Seller's satisfaction to be thus defective. This Warranty does not apply to defects caused by shipping damages, or to any products manufactured by Seller which have been subject to improper installation, misuse, neglect, accident, ordinary wear and tear, or Buyer's attempts to use any products beyond its mechanical, thermal, or electrical capacity. Notice of a defective product must be given to Seller in writing within 48 hours of discovery and be free, without limitation of labor charges, lost profits, expenses of repair or other costs incidental to replacement. All transportation costs incurred in shipping product to or from Seller's plant shall be at the Buyer's expense. The aforementioned provisions do not extend the original Warranty period of any product which has either been partially repaired or replaced by the Seller.

FOR FURTHER TECHNICAL ASSISTANCE

Contact your RK2 distributor